



Introduction to Amazon Web Services (AWS) Certifications Roadmap

Host: 陳仁偉 教授 (Prof. Jen Wel Chen)

Information Management, SEC, Chinese Culture University

Time: 2022/3/13 (Sunday) 13:00-15:00

Place: 202教室 大夏館 台北市建國南路二段231號

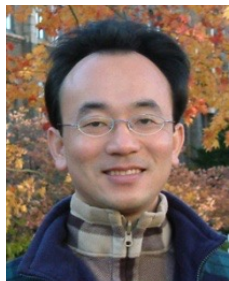

戴敏育 副教授

Min-Yuh Day, Ph.D, Associate Professor

國立臺北大學 資訊管理研究所

Institute of Information Management, National Taipei University

<https://web.ntpu.edu.tw/~myday>

2022-03-13





戴敏育 博士

(Min-Yuh Day, Ph.D.)

aws educate | Cloud Ambassador

2020 Cohort

國立臺北大學 資訊管理研究所 副教授
中央研究院 資訊科學研究所 訪問學人
國立臺灣大學 資訊管理 博士

Publications Co-Chairs, IEEE/ACM International Conference on Advances in Social Networks Analysis and Mining (ASONAM 2013-)

Program Co-Chair, IEEE International Workshop on Empirical Methods for Recognizing Inference in Text (IEEE EM-RITE 2012-)

Publications Chair, The IEEE International Conference on Information Reuse and Integration for Data Science (IEEE IRI)



Outline

- **Amazon Web Services (AWS)**
- **AWS Certifications Roadmap**



AWS Products and Services



Analytics



Application Integration



AR & VR



AWS Cost Management



Blockchain



Business Applications



Compute



Customer Engagement



Database



Developer Tools



End User Computing



Game Tech



Internet of Things



Machine Learning



Management & Governance



Media Services



Migration & Transfer



Mobile



Networking & Content Delivery



Quantum Technologies



Robotics



Satellite



Security, Identity & Compliance



Storage



AWS Compute



Compute

Amazon EC2

Virtual servers in the cloud

Amazon EC2 Auto Scaling

Scale compute capacity to meet demand

Amazon Elastic Container Registry

Store and retrieve docker images

Amazon Elastic Container Service

Run and manage docker containers

Amazon Elastic Kubernetes Service

Run managed Kubernetes on AWS

Amazon Lightsail

Launch and manage virtual private servers

AWS Batch

Run batch jobs at any scale

AWS Elastic Beanstalk

Run and manage web apps

AWS Fargate

Run containers without managing servers or clusters

AWS Lambda

Run code without thinking about servers

AWS Outposts

Run AWS infrastructure on-premises

AWS Serverless Application Repository

Discover, deploy, and publish serverless applications

AWS Wavelength

Deliver ultra-low latency applications for 5G devices

VMware Cloud on AWS

Build a hybrid cloud without custom hardware



AWS Database



Amazon Aurora
High Performance Managed Relational Database

Amazon DynamoDB
Managed NoSQL Database

Amazon DocumentDB (with MongoDB compatibility)
Fully managed document database

Amazon ElastiCache
In-memory Caching System

Amazon Managed Apache Cassandra Service
Managed Cassandra-compatible database

Amazon Neptune
Fully Managed Graph Database Service

Amazon Quantum Ledger Database (QLDB)
Fully managed ledger database

Amazon RDS
Managed Relational Database Service for MySQL, PostgreSQL, Oracle, SQL Server, and MariaDB

Amazon RDS on VMware
Automate on-premises database management

Amazon Redshift
Fast, Simple, Cost-effective Data Warehousing

Amazon Timestream
Fully managed time series database

AWS Database Migration Service
Migrate Databases with Minimal Downtime



AWS Storage



Amazon Simple Storage Service (S3)
Scalable Storage in the Cloud

Amazon FSx for Lustre
High-performance file system integrated with S3

AWS Backup
Centralized backup across AWS services

CloudEndure Disaster Recovery
Highly automated disaster recovery

Amazon Elastic Block Store (EBS)
EC2 block storage volumes

Amazon FSx for Windows File Server
Fully managed Windows native file system

AWS Snow Family
Physical devices to migrate data into and out of AWS

Amazon Elastic File System (EFS)
Fully managed file system for EC2

Amazon S3 Glacier
Low-cost Archive Storage in the Cloud

AWS Storage Gateway
Hybrid Storage Integration



AWS Networking & Content Delivery



Networking & Content Delivery

Amazon VPC

Isolated Cloud Resources

Amazon API Gateway

Build, Deploy, and Manage APIs

Amazon CloudFront

Global Content Delivery Network

Amazon Route 53

Scalable Domain Name System

AWS PrivateLink

Securely Access Services Hosted on AWS

AWS App Mesh

Monitor and control microservices

AWS Cloud Map

Application resource registry for microservices

AWS Direct Connect

Dedicated Network Connection to AWS

AWS Global Accelerator

Improve application availability and performance

AWS Transit Gateway

Easily scale VPC and account connections

Elastic Load Balancing

Distribute incoming traffic across multiple targets



AWS Security, Identity & Compliance



Security, Identity &
Compliance

AWS Identity & Access Management
Manage User Access and Encryption Keys

Amazon Cognito
Identity Management for your Apps

Amazon Detective
Investigate potential security issues

Amazon GuardDuty
Managed Threat Detection Service

Amazon Inspector
Analyze Application Security

Amazon Macie
Discover, Classify, and Protect your Data

AWS Artifact
On-demand access to AWS compliance reports

AWS Certificate Manager
Provision, Manage, and Deploy SSL/TLS Certificates

AWS CloudHSM
Hardware-based Key Storage for Regulatory Compliance

AWS Directory Service
Host and Manage Active Directory

AWS Firewall Manager
Central Management of Firewall Rules

AWS Key Management Service
Managed Creation and Control of Encryption Keys

AWS Resource Access Manager
Simple, secure service to share AWS resources

AWS Secrets Manager
Rotate, Manage, and Retrieve Secrets

AWS Security Hub
Unified security and compliance center

AWS Shield
DDoS Protection

AWS Single Sign-On
Cloud Single Sign-On (SSO) Service

AWS WAF
Filter Malicious Web Traffic



AWS Cost Management



AWS Cost Management

AWS Cost Explorer

Analyze Your AWS Cost and Usage

AWS Budgets

Set Custom Cost and Usage Budgets

AWS Cost and Usage Report

Access Comprehensive Cost and Usage Information

Reserved Instance Reporting

Dive Deeper into Your Reserved Instances (RIs)

Savings Plans

Save up to 72% on compute usage with flexible pricing



AWS Services

- **Amazon EC2**
 - Virtual servers in the cloud
- **Amazon Simple Storage Service (S3)**
 - Scalable storage in the cloud
- **Amazon Aurora**
 - High performance managed relational database
- **Amazon DynamoDB**
 - Managed NoSQL database
- **Amazon RDS**
 - Managed relational database service for MySQL, PostgreSQL, Oracle, SQL Server, and MariaDB



AWS Services

- **AWS Lambda**
 - Run code without thinking about servers
- **AWS Elastic Beanstalk**
 - Run and manage web apps
- **Amazon VPC**
 - Isolated cloud resources
- **Amazon Lightsail**
 - Launch and manage virtual private servers
- **Amazon SageMaker**
 - Build, train, and deploy machine learning models at scale

Available AWS Certifications

3

Professional

Two years of comprehensive experience designing, operating, and troubleshooting solutions using the AWS Cloud

SAP



2

Associate

One year of experience solving problems and implementing solutions using the AWS Cloud

SAA



1

Foundational

Six months of fundamental AWS Cloud and industry knowledge

CLF

Cloud Practitioner



Specialty

Technical AWS Cloud experience in the Specialty domain as specified in the exam guide



Available AWS Certifications

3

專業級

兩年使用 AWS 雲端設計、操作及疑難排解解決方案的廣泛經驗

SAP



2

助理級

一年使用 AWS 雲端解決問題和實作解決方案的經驗

SAA



架構師



營運



開發人員

1

基礎

六個月的基礎 AWS 雲端和產業知識

CLF

雲端從業人員



專家級

考試指南中指定的專業領域中的 AWS 雲端技術經驗





AWS Certification

aws Contact Us Support English My Account Sign In to the Console

Products Solutions Pricing Documentation Learn Partner Network AWS Marketplace Customer Enablement Events Explore More

Training and Certification Get Trained Get Certified Develop Your Team AWS Partner Training Education Programs Blog

aws training and certification

AWS Certification

Validate technical skills and cloud expertise to grow your career and business.

[Schedule an exam](#) [Prepare for an exam](#)

Get started

Certification exam guides and details

Explore our role-based certifications and our Specialty certifications in specific technical areas. Select an exam to learn more:

Select ▼

Options for taking your exam

Curious about how to take your AWS Certification exam? We offer flexible, convenient options for taking exams so you can select what works best for you.

[Learn more »](#)

Access your AWS Certification Account

Schedule and take exams from your AWS Certification Account. You can also access your AWS Certified benefits, such as your digital badge and 50% discount voucher for a future exam.

<https://aws.amazon.com/certification/>



AWS Certification



聯絡我們 支援 ▾ 中文(繁體) ▾ 我的帳戶 ▾

登入主控台

產品 解決方案 定價 文件 了解 合作夥伴網路 AWS Marketplace 客戶支援 事件 進一步探索 🔍

培訓與認證 取得培訓 ▾ 取得認證 ▾ 開發您的團隊 AWS 合作夥伴培訓 ▾ 教育計劃 ▾ 部落格



AWS Certification

參與技術、技能、雲端專業知識和能力的驗證，以拓展您的職業和業務發展。

安排考試

準備考試

入門

認證考試指南和詳細資訊

探索我們以角色為基礎的認證和我們在特定技術領域的專家級認證。選取考試以進一步了解：

選取 ▾

參加考試的選項

想知道如何參加 AWS Certification 考試嗎？我們提供靈活、便利的考試選項，以便您可以選擇最適合您的選項。

存取您的 AWS Certification 帳戶

從 AWS Certification 帳戶安排及參加考試。也可以存取您的 AWS Certification 權益，例如數位徽章和日後考試費用 5 折優惠券。

<https://aws.amazon.com/certification/>



AWS Certification

Professional

Two years of comprehensive experience designing, operating, and troubleshooting solutions using the AWS Cloud



Associate

One year of experience solving problems and implementing solutions using the AWS Cloud



Specialty

Technical AWS Cloud experience in the Specialty domain as specified in the exam guide



2

SAA

Architect

Operations

Developer

1

Foundational

Six months of fundamental AWS Cloud and industry knowledge

Cloud Practitioner



CLF

<https://aws.amazon.com/certification/>



AWS Certification



Format

65 questions; either multiple choice or multiple response



Type

Foundational



Delivery Method

Testing center or online proctored exam



Time

90 minutes to complete the exam



Cost

100 USD (Practice Exam: 20 USD)



Language

Available in English, Indonesian (Bahasa), Japanese, Korean, and Simplified Chinese

Foundational

Six months of fundamental AWS
Cloud and industry knowledge

Cloud
Practitioner



<https://aws.amazon.com/certification/>



AWS Certification



Format

65 questions; either multiple choice or multiple response



Type

Associate



Delivery Method

Testing center or online proctored exam



Time

130 minutes to complete the exam



Cost

150 USD (Practice exam: 20 USD)



Language

Available in English, Japanese, Korean, and Simplified Chinese

Associate

One year of experience solving problems and implementing solutions using the AWS Cloud



Architect



Operations



Developer



AWS Certification

Professional

Two years of comprehensive experience designing, operating, and troubleshooting solutions using the AWS Cloud



Format

75 questions; either multiple choice or multiple response



Type

Professional



Delivery Method

Testing center or online proctored exam



Time

180 minutes to complete the exam



Cost

300 USD (Practice Exam: 40 USD)



Language

Available in English, Japanese, Korean, and Simplified Chinese



AWS Certification



Format

65 questions; either multiple choice or multiple response



Type

Associate



Delivery Method

Testing center or online proctored exam



Time

130 minutes to complete the exam



Cost

150 USD (Practice exam: 20 USD)



Language

Available in English, Japanese, Korean, and Simplified Chinese

Associate

One year of experience solving problems and implementing solutions using the AWS Cloud



Architect



Operations



Developer



AWS Certification



Format

65 questions; either multiple choice or multiple response



Type

Associate



Delivery Method

Testing center or online proctored exam



Time

130 mins to complete the exam



Cost

150 USD (Practice exam: 20 USD)



Language

Available in English, Japanese, Korean, and Simplified Chinese

Associate

One year of experience solving problems and implementing solutions using the AWS Cloud



Architect



Operations



Developer



AWS Certification

Professional

Two years of comprehensive experience designing, operating, and troubleshooting solutions using the AWS Cloud



Format

75 questions; either multiple choice or multiple response



Type

Professional



Delivery Method

Testing center or online proctored exam



Time

180 minutes to complete the exam



Cost

300 USD (Practice exam: 40 USD)



Language

Available in English, Japanese, Korean, and Simplified Chinese



AWS Certification

Specialty

Technical AWS Cloud experience in the Specialty domain as specified in the **exam guide**



Format

65 questions; either multiple choice or multiple response



Type

Specialty



Delivery Method

Testing center or online proctored exam



Time

180 minutes to complete the exam



Cost

300 USD (Practice exam: 40 USD)



Language

Available in English, Japanese, Korean, and Simplified Chinese

AWS Certified Cloud Practitioner



- Level: **Foundational**
- Length: **90 minutes** to complete the exam
- Cost: **100 USD**
- Format: **65 questions**;
either multiple choice or multiple response
- Delivery method: **Pearson VUE** and PSI;
testing center or online proctored exam

AWS Certified Solutions Architect – Associate



- Level: **Associate**
- Length: **130 minutes** to complete the exam
- Cost: **150 USD**
- Format: **65 questions**;
either multiple choice or multiple response
- Delivery method: **Pearson VUE** and PSI;
testing center or online proctored exam

AWS Certified SysOps Administrator - Associate



- Level: **Associate**
- Length: **180 minutes** to complete the exam
- Cost: **150 USD**
- Format: **65 scoring** opportunities that may be multiple choice, multiple response, or exam lab
- Delivery method: **Pearson VUE** and PSI; testing center or online proctored exam

AWS Certified Solutions Architect – Associate



- Level: **Associate**
- Length: **130 minutes** to complete the exam
- Cost: **150 USD**
- Format: **65 questions**;
either multiple choice or multiple response
- Delivery method: **Pearson VUE** and PSI;
testing center or online proctored exam

AWS Certified Solutions Architect - Professional



- Level: **Professional**
- Length: **180 minutes** to complete the exam
- Cost: **300 USD**
- Format: **75 questions**; either multiple choice or multiple response
- Delivery method: **Pearson VUE** and PSI; testing center or online proctored exam

AWS Certified DevOps Engineer - Professional



- Level: **Professional**
- Length: **180 minutes** to complete the exam
- Cost: **300 USD**
- Format: **75 questions**; either multiple choice or multiple response
- Delivery method: **Pearson VUE** and PSI; testing center or online proctored exam

AWS Certified Security - Specialty



- Level: **Specialty**
- Length: **170 minutes** to complete the exam
- Cost: **300 USD**
- Format: **65 questions**; either multiple choice or multiple response
- Delivery method: **Pearson VUE** and PSI; testing center or online proctored exam

AWS Certified Database - Specialty



- Level: **Specialty**
- Length: **180 minutes** to complete the exam
- Cost: **300 USD**
- Format: **65 questions**; either multiple choice or multiple response
- Delivery method: **Pearson VUE** and PSI; testing center or online proctored exam

AWS Certified Machine Learning – Specialty



- Level: **Specialty**
- Length: **180 minutes** to complete the exam
- Cost: **300 USD**
- Format: **65 questions**; either multiple choice or multiple response
- Delivery method: **Pearson VUE** and PSI; testing center or online proctored exam

AWS Certified Data Analytics - Specialty



- Level: **Specialty**
- Length: **180 minutes** to complete the exam
- Cost: **300 USD**
- Format: **65 questions**; either multiple choice or multiple response
- Delivery method: **Pearson VUE** and PSI; testing center or online proctored exam

AWS Certified Advanced Networking - Specialty



- Level: **Specialty**
- Length: **170 minutes** to complete the exam
- Cost: **300 USD**
- Format: **65 questions**; either multiple choice or multiple response
- Delivery method: **Pearson VUE** and PSI; testing center or online proctored exam

AWS Certifications Roadmap



AWS Certifications Roadmap

Cloud Architect



AWS Certifications Roadmap

Cloud Developer



AWS Certifications Roadmap

DevOps



AWS Certifications Roadmap

Data Analytics / Machine Learning



AWS Certifications Roadmap

Security



AWS Certified Cloud Practitioner (CLF-C01)





AWS Certified Cloud Practitioner

- **This certification provides individuals in a larger variety of cloud and technology roles with a way to validate their AWS Cloud knowledge and enhance their professional credibility.**
- **This exam covers four domains, including cloud concepts, security, technology, and billing and pricing.**



AWS Certified Solutions Architect – Associate (SAA-C02)





AWS Certified Solutions Architect – Associate

- **This certification validates your ability to effectively demonstrate knowledge of how to architect and deploy secure and robust applications on AWS technologies.**
- **This exam is for anyone with at least one year of hands-on experience designing available, cost-efficient, fault-tolerant, and scalable and distributed systems on AWS.**



AWS Academy and Certifications

- **AWS Academy Cloud Foundations (ACF)**

- **AWS Certified Cloud Practitioner (CLF-C01)**

- <https://aws.amazon.com/certification/certified-cloud-practitioner/>

- **AWS Academy Cloud Architecting (ACA)**

- **AWS Certified Solutions Architect – Associate (SAA-C02)**

- <https://aws.amazon.com/certification/certified-solutions-architect-associate/>

<https://aws.amazon.com/training/awsacademy/>

1



2





AWS Certified Cloud Practitioner (CLF-C01)

Domain	% of Examination
Domain 1: Cloud Concepts	26%
Domain 2: Security and Compliance	25%
Domain 3: Technology	33%
Domain 4: Billing and Pricing	16%
TOTAL	100%



AWS Certified Solutions Architect – Associate (SAA-C02)

Domain	% of Examination
Domain 1: Design Resilient Architectures	30%
Domain 2: Design High-Performing Architectures	28%
Domain 3: Specify Secure Applications and Architectures	24%
Domain 4: Design Cost-Optimized Architectures	18%
TOTAL	100%

AWS Certified Cloud Practitioner (CLF-C01)





AWS Certified Cloud Practitioner (CLF-C01)

- **Domain 1: Cloud Concepts**
 - **1.1 Define the AWS Cloud and its value proposition**
 - **1.2 Identify aspects of AWS Cloud economics**
 - **1.3 List the different cloud architecture design principles**



AWS Certified Cloud Practitioner (CLF-C01)

- **Domain 2: Security and Compliance**
 - **2.1 Define the AWS shared responsibility model**
 - **2.2 Define AWS Cloud security and compliance concepts**
 - **2.3 Identify AWS access management capabilities**
 - **2.4 Identify resources for security support**



AWS Certified Cloud Practitioner (CLF-C01)

- **Domain 3: Technology**
 - **3.1 Define methods of deploying and operating in the AWS Cloud**
 - **3.2 Define the AWS global infrastructure**
 - **3.3 Identify the core AWS services**
 - **3.4 Identify resources for technology support**



AWS Certified Cloud Practitioner (CLF-C01)

- **Domain 4: Billing and Pricing**
 - **4.1 Compare and contrast the various pricing models for AWS**
 - **4.2 Recognize the various account structures in relation to AWS billing and pricing**
 - **4.3 Identify resources available for billing support**

AWS Certified Solutions Architect – Associate (SAA-C02)





AWS Certified Solutions Architect – Associate (SAA-C02)

- **Domain 1: Design Resilient Architectures**
 - **1.1 Design a multi-tier architecture solution**
 - **1.2 Design highly available and/or fault-tolerant architectures**
 - **1.3 Design decoupling mechanisms using AWS services**
 - **1.4 Choose appropriate resilient storage**



AWS Certified Solutions Architect – Associate (SAA-C02)

- **Domain 2: Design **High-Performing** Architectures**
 - 2.1 Identify elastic and scalable compute solutions for a workload
 - 2.2 Select high-performing and scalable storage solutions for a workload
 - 2.3 Select high-performing networking solutions for a workload
 - 2.4 Choose high-performing database solutions for a workload



AWS Certified Solutions Architect – Associate (SAA-C02)

- **Domain 3: Design **Secure** Applications and Architectures**
 - **3.1 Design secure access to AWS resources**
 - **3.2 Design secure application tiers**
 - **3.3 Select appropriate data security options**



AWS Certified Solutions Architect – Associate (SAA-C02)

- **Domain 4: Design **Cost-Optimized** Architectures**
 - 4.1 Identify cost-effective storage solutions
 - 4.2 Identify cost-effective compute and database services
 - 4.3 Design cost-optimized network architectures



AWS Certifications

Exam Pricing

Exam Type	Price in USD
Foundational	\$100
Associate	\$150
Professional	\$300
Specialty	\$300



AWS Certified Security – Specialty

validates expertise in securing data and workloads in the AWS Cloud



AWS Certified Security - Specialty

- AWS Certified Security – Specialty is intended for individuals who perform a security role and have at least two years of hands-on experience securing AWS workloads.
 - Five years of IT security experience in designing and implementing security solutions and at least two years of hands-on experience in securing AWS workloads
 - Working knowledge of AWS security services and features of services to provide a secure production environment and an understanding of security operations and risks
 - Knowledge of the AWS shared responsibility model and its application; security controls for workloads on AWS; logging and monitoring strategies; cloud security threat models; patch management and security automation; ways to enhance AWS security services with third-party tools and services; and disaster recovery controls, including BCP and backups, encryption, access control, and data retention
 - Understanding of specialized data classifications and AWS data protection mechanisms, data-encryption methods and AWS mechanisms to implement them, and secure internet protocols and AWS mechanisms to implement them
 - Ability to make tradeoff decisions with regard to cost, security, and deployment complexity to meet a set of application requirements



AWS Certified Security - Specialty

- AWS Certified Security – Specialty 適用於曾擔任安全角色而且至少兩年保護 AWS 工作負載實務經驗的個人。
 - 具備五年的安全解決方案設計與實作相關 IT 安全工作經驗，以及至少兩年的 AWS 工作負載安全保護實務經驗。
 - 具有 AWS 安全服務和服務功能的工作知識，可提供安全的生產環境且理解安全作業和風險
 - 了解 AWS 共同的責任模型及其應用；AWS 上工作負載的安全控制；日誌記錄和監控策略；雲端安全威脅模型；修補程式管理和安全自動化；使用第三方工具和服務增強 AWS 安全服務的方法；以及災難復原控制，包括 BCP 和備份、加密、存取控制和資料保留
 - 了解專門的資料分類和 AWS 資料保護機制、資料加密方法和實施它們的 AWS 機制，以及安全的網際網路通訊協定和實作它們的 AWS 機制
 - 能夠根據成本、安全性和部署複雜性做出權衡的決策，滿足一組應用程式需求

企業雲端運算入門

(Foundation of Business Cloud Computing)

雲端概念概述

(Cloud Concepts Overview)

企業雲端運算入門 (Foundation of Business Cloud Computing) (BA4, NTPU) (Spring 2022)
(AWS Academy Cloud Foundations; ACF) (AWS Certified Cloud Practitioner)
(BA4, NTPU) (3 Credits, Elective) (U4010) (自主學習課程)(商業智慧與大數據分析學士學分學程)
(1102) (國立台北大學企管系4A, 4B) (選修3學分) (授課教師：謝榮桂，戴敏育) (2022.02 - 2022.06)
(週三 Wed, 6, 7, 8, 14:10-17:00) (台北大學三峽校區 商3F10)



謝榮桂 (Jung-Kuei Hsieh), 戴敏育 (Min-Yuh Day)

National Taipei University

國立臺北大學

2022-02-23

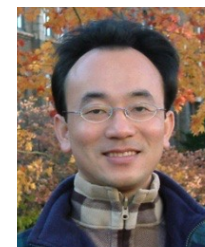



教學目標



- 本課程主要介紹亞馬遜公司的雲端運算服務 **Amazon Web Services (AWS)**，對於想要全面瞭解企業雲端運算概念的同學，本課程將詳細介紹
雲概念、AWS 核心服務、安全性、架構、定價和相關支援等服務，並以通過認證 AWS Certified Cloud Practitioner 為目標。



Course Objectives

- This course introduces **Amazon Web Services (AWS)**, the cloud computing service of Amazon.
- For students who want to fully understand the concept of enterprise cloud computing, this course will introduce the AWS Academy Cloud Foundations.
- Topics include **Cloud Concepts Overview, Cloud Economics and Billing, AWS Global Infrastructure Overview, AWS Cloud Security, Networking and Content Delivery, Cloud Compute, Cloud Storage, Cloud Databases, Cloud Architecture, Cloud Automatic Scaling and Monitoring.**
- The course objective is training students to pass the certification of **AWS Certified Cloud Practitioner.**

內容綱要

- 說明如何使用 AWS 帳戶的最佳實務
- 說明AWS架構完善的框架和設計原則
- 說明AWS高可用性和可靠性
- 描述AWS設計決策的業務影響
- 描述AWS如何設置組織結構以簡化帳單和提高帳戶可見性
- 說明AWS替代支援選項和功能

Course Outline

- 1. Cloud Concepts Overview**
- 2. Cloud Economics and Billing**
- 3. AWS Global Infrastructure Overview**
- 4. AWS Cloud Security**
- 5. Networking and Content Delivery**
- 6. Cloud Compute**
- 7. Cloud Storage**
- 8. Cloud Databases**
- 9. Cloud Architecture**
- 10. Cloud Automatic Scaling and Monitoring**

課程大綱 (Syllabus)



週次 (Week)	日期 (Date)	內容 (Subject/Topics)
1	2022/02/23	雲端概念概述 (Cloud Concepts Overview)
2	2022/03/02	雲端經濟與計費 (Cloud Economics and Billing)
3	2022/03/09	AWS全球基礎設施概述 (AWS Global Infrastructure Overview)
4	2022/03/16	AWS雲端安全 (AWS Cloud Security)
5	2022/03/23	網路和內容交付 (Networking and Content Delivery)
6	2022/03/30	雲端計算 (Cloud Compute)

課程大綱 (Syllabus)



週次 (Week)	日期 (Date)	內容 (Subject/Topics)
7	2022/04/06	放假一天 (Make-up Holiday, No Classes)
8	2022/04/13	雲端儲存 (Cloud Storage)
9	2022/04/20	雲端數據庫 (Cloud Databases)
10	2022/04/27	雲端架構 (Cloud Architecture)
11	2022/05/04	雲端自動擴展和監控 (Cloud Automatic Scaling and Monitoring)
12	2022/05/11	學生自主學習 (Self-learning)

課程大綱 (Syllabus)



週次 (Week)	日期 (Date)	內容 (Subject/Topics)
13	2022/05/18	學生自主學習 (Self-learning)
14	2022/05/25	雲端專案成果報告與討論 (Cloud Project Presentation and Discussion)
15	2022/06/01	學生自主學習 (Self-learning)
16	2022/06/08	期末專案成果報告 (Final Project Presentation)
17	2022/06/15	學生自主學習 (Self-learning)
18	2022/06/22	學生自主學習 (Self-learning)



AWS Certified Cloud Practitioner

- **This certification provides individuals in a larger variety of cloud and technology roles with a way to validate their AWS Cloud knowledge and enhance their professional credibility.**
- **This exam covers four domains, including cloud concepts, security, technology, and billing and pricing.**





AWS Certified Solutions Architect – Associate

- **This certification validates your ability to effectively demonstrate knowledge of how to architect and deploy secure and robust applications on AWS technologies.**
- **This exam is for anyone with at least one year of hands-on experience designing available, cost-efficient, fault-tolerant, and scalable and distributed systems on AWS.**





Web Application with AWS Core Services

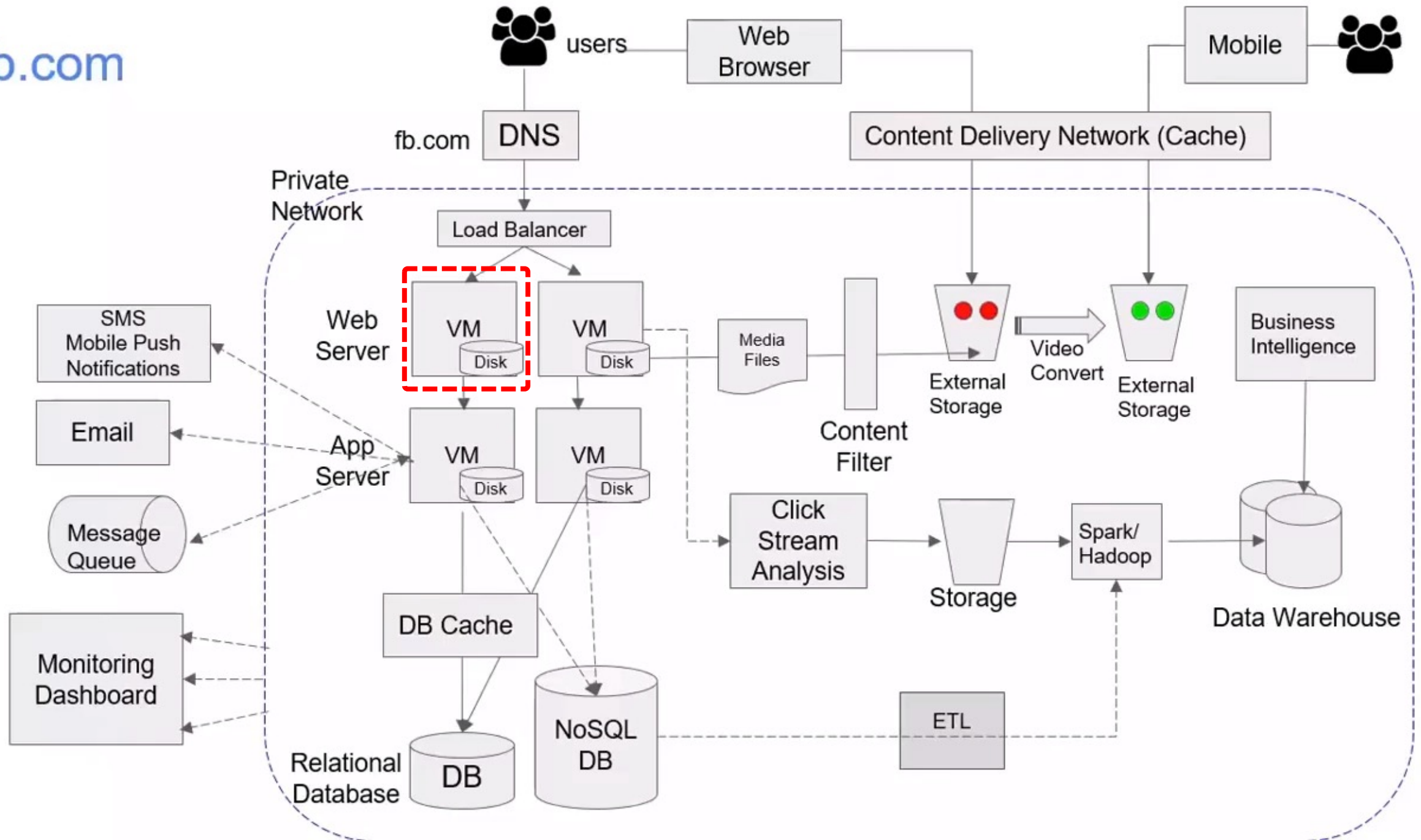

fb.com on AWS

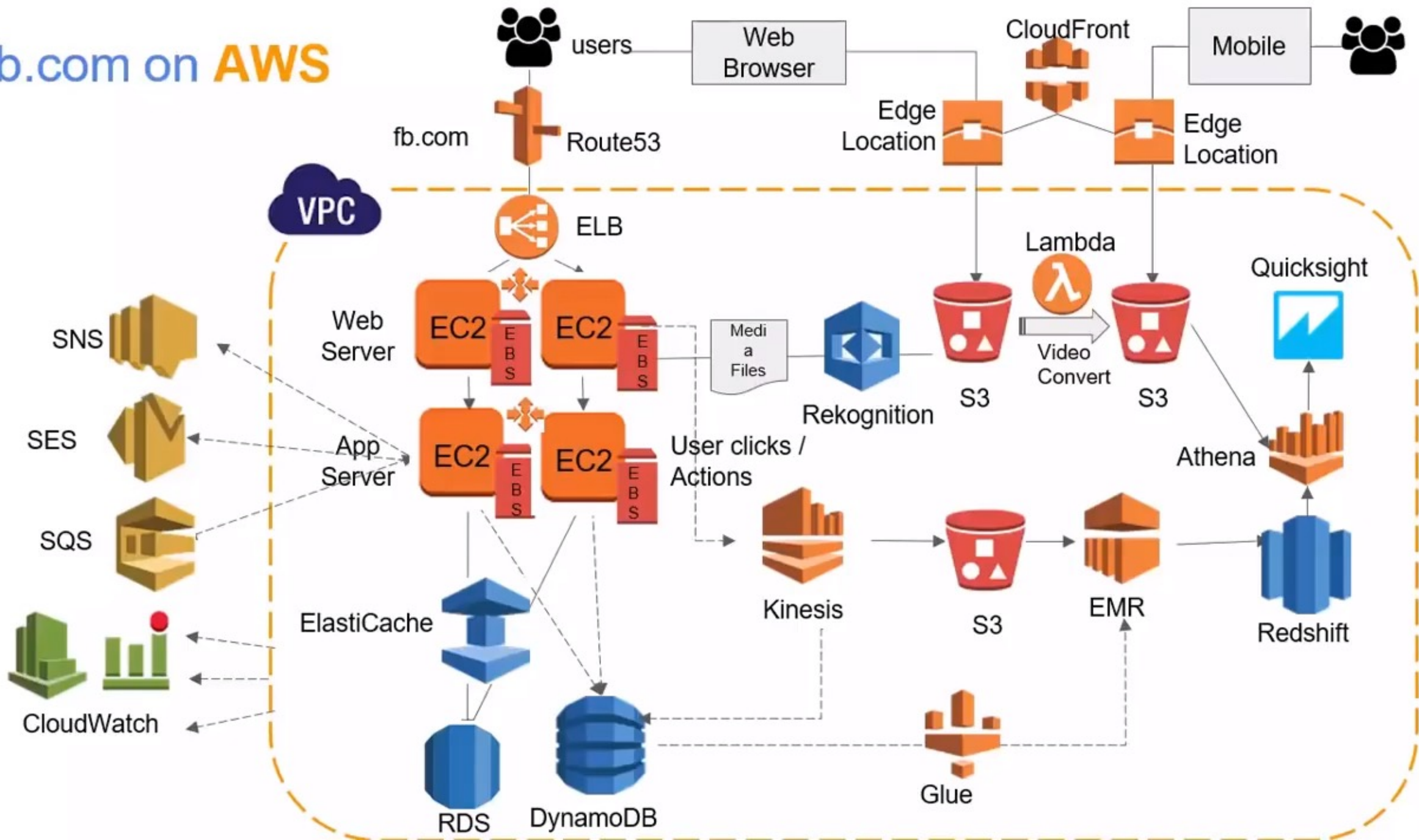

fb.com on AWS

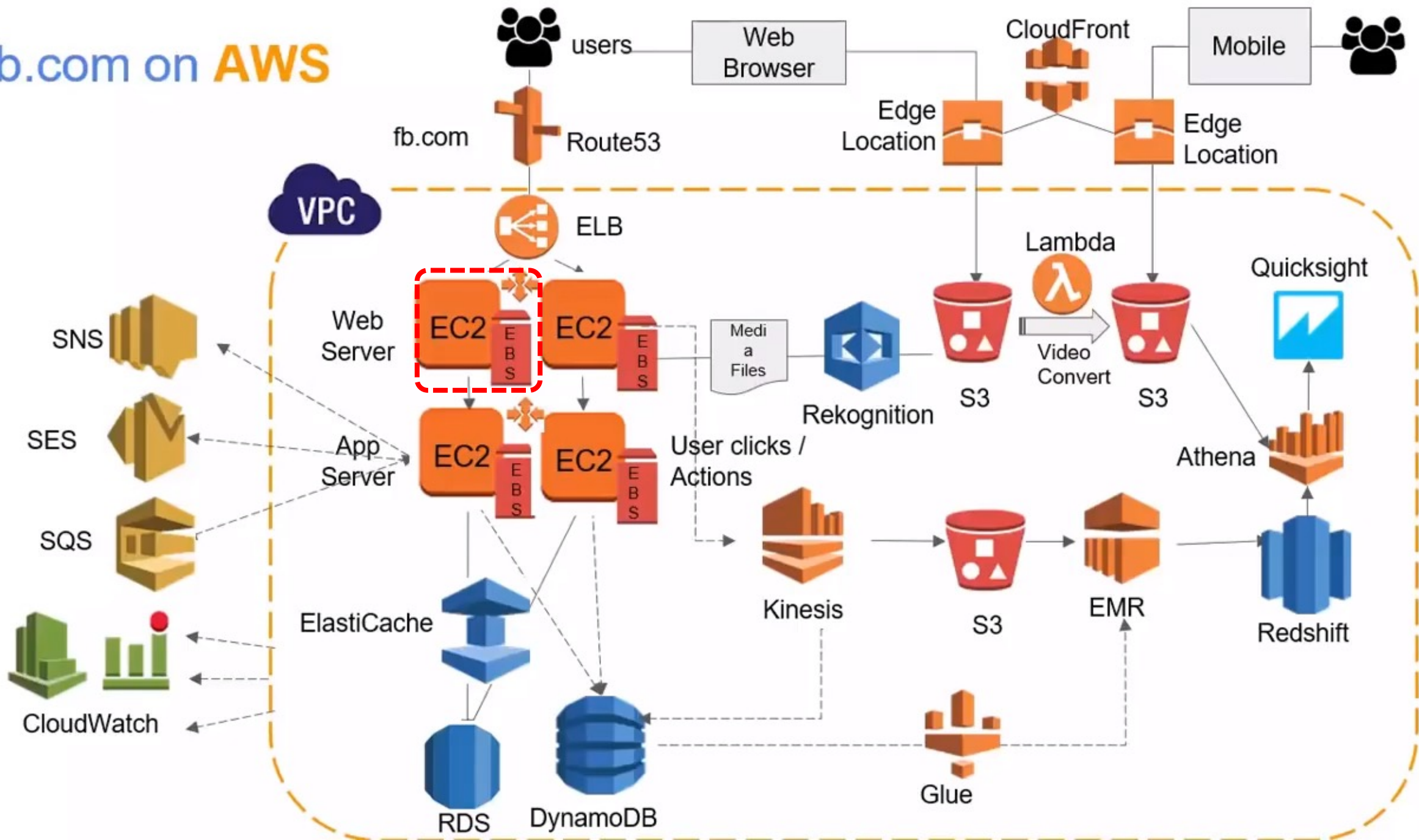

fb.com on AWS

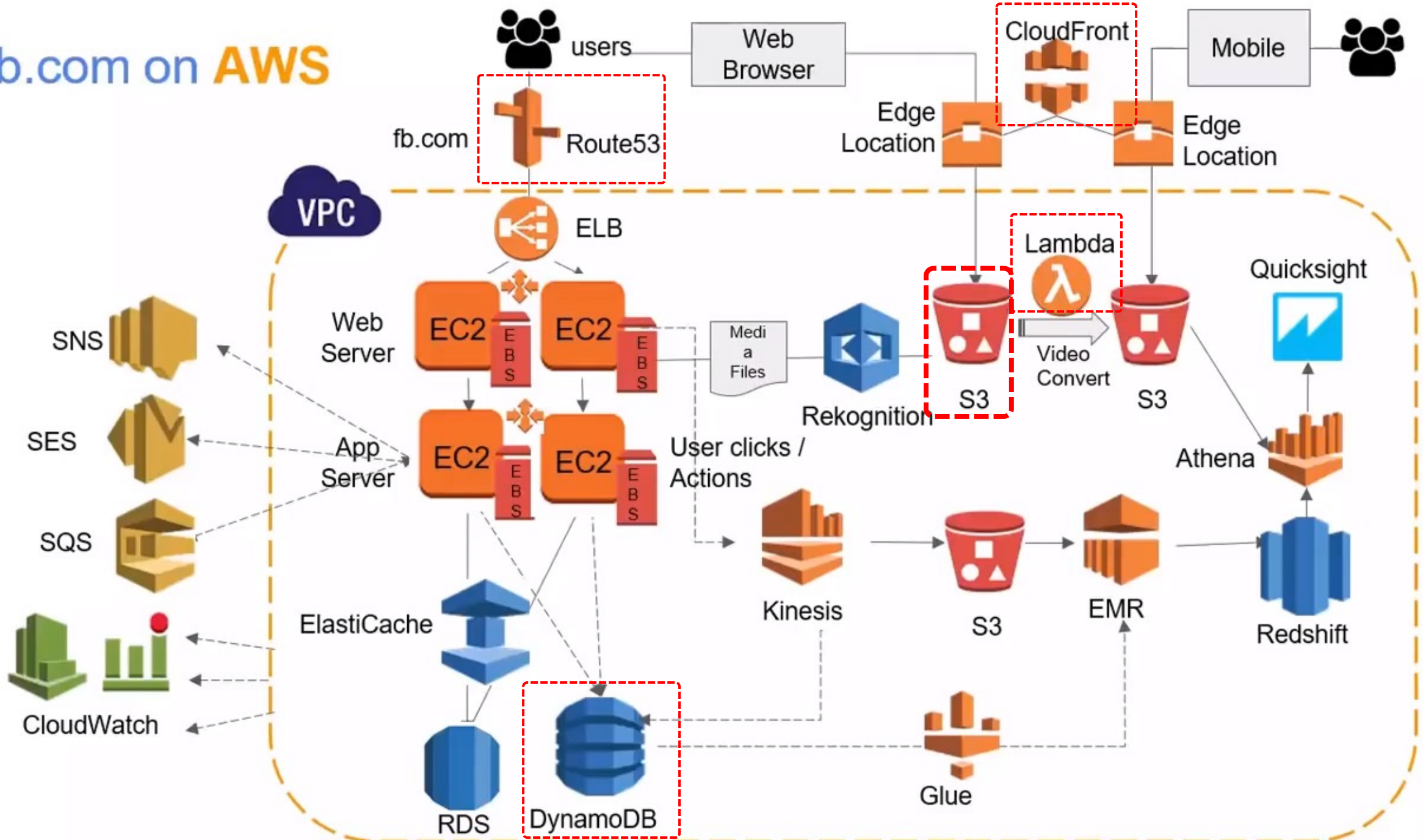

AWS Application Services

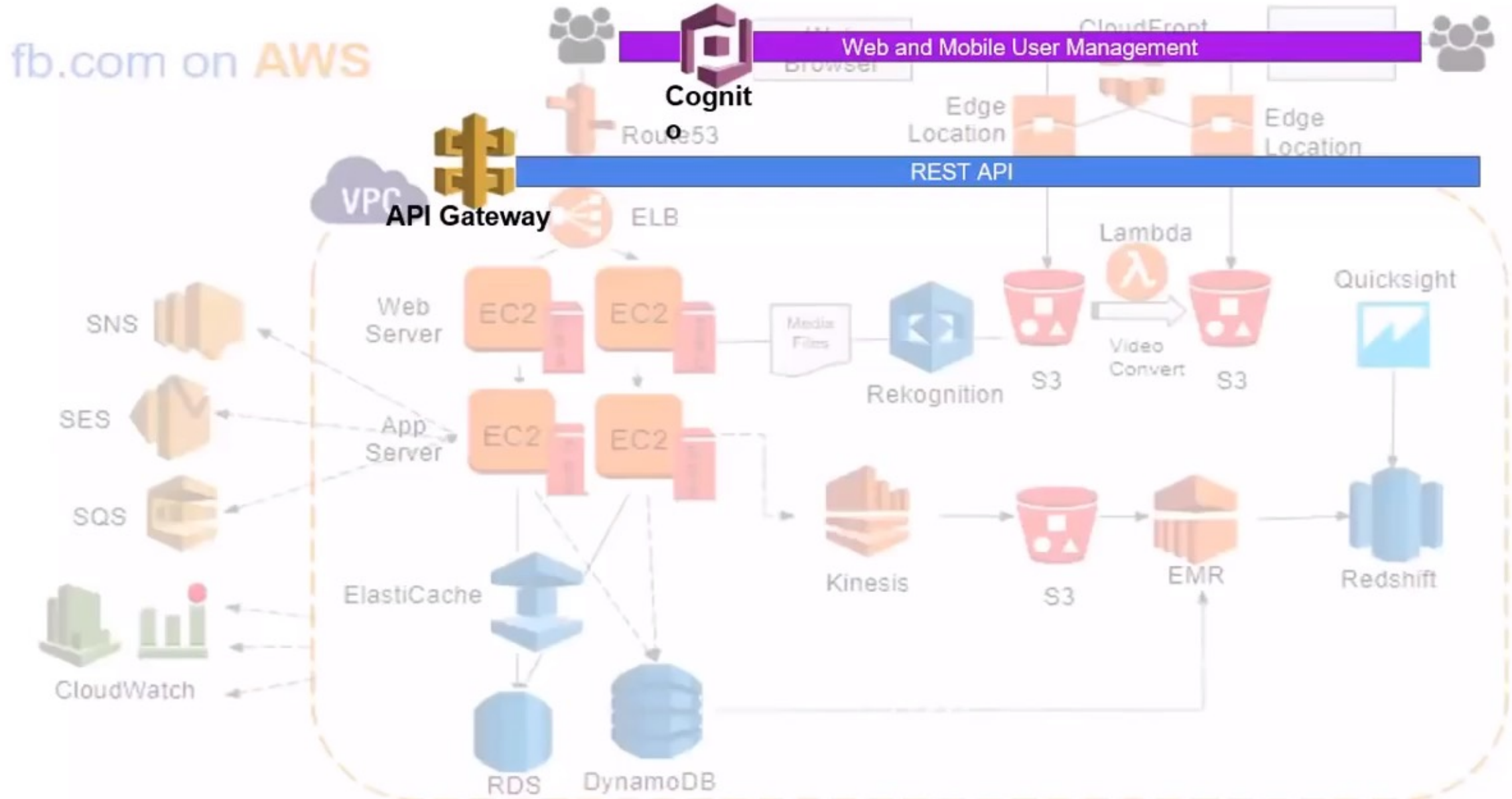

Source: AWS Training Center (2019), Introduction to AWS Services, <https://youtu.be/Z3SYDTMP3ME>

AWS Security Services

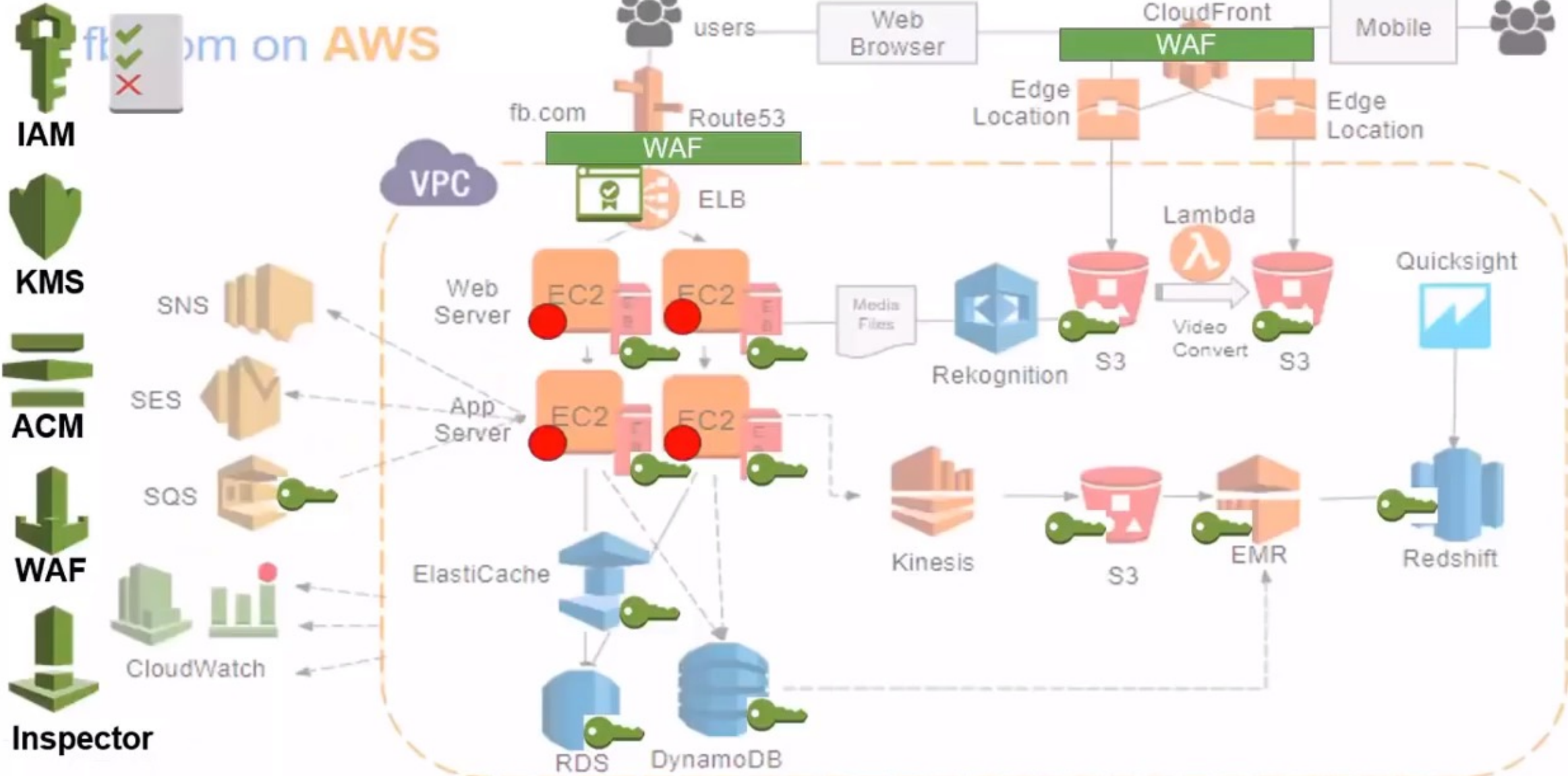

AWS Development and DevOps Services

AWS Region

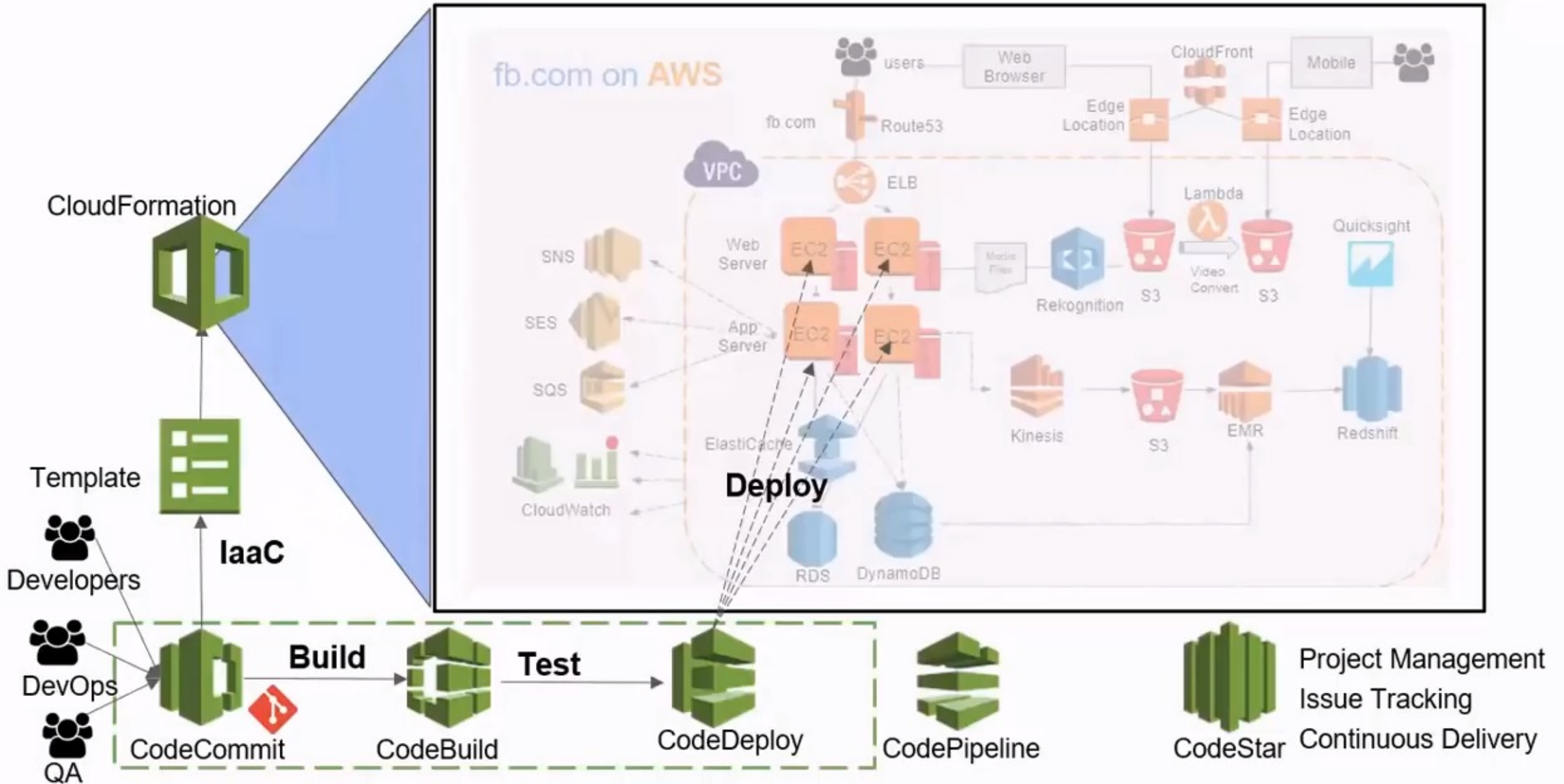



AWS Serverless Architecture

aws AWS Serverless Airline Booking

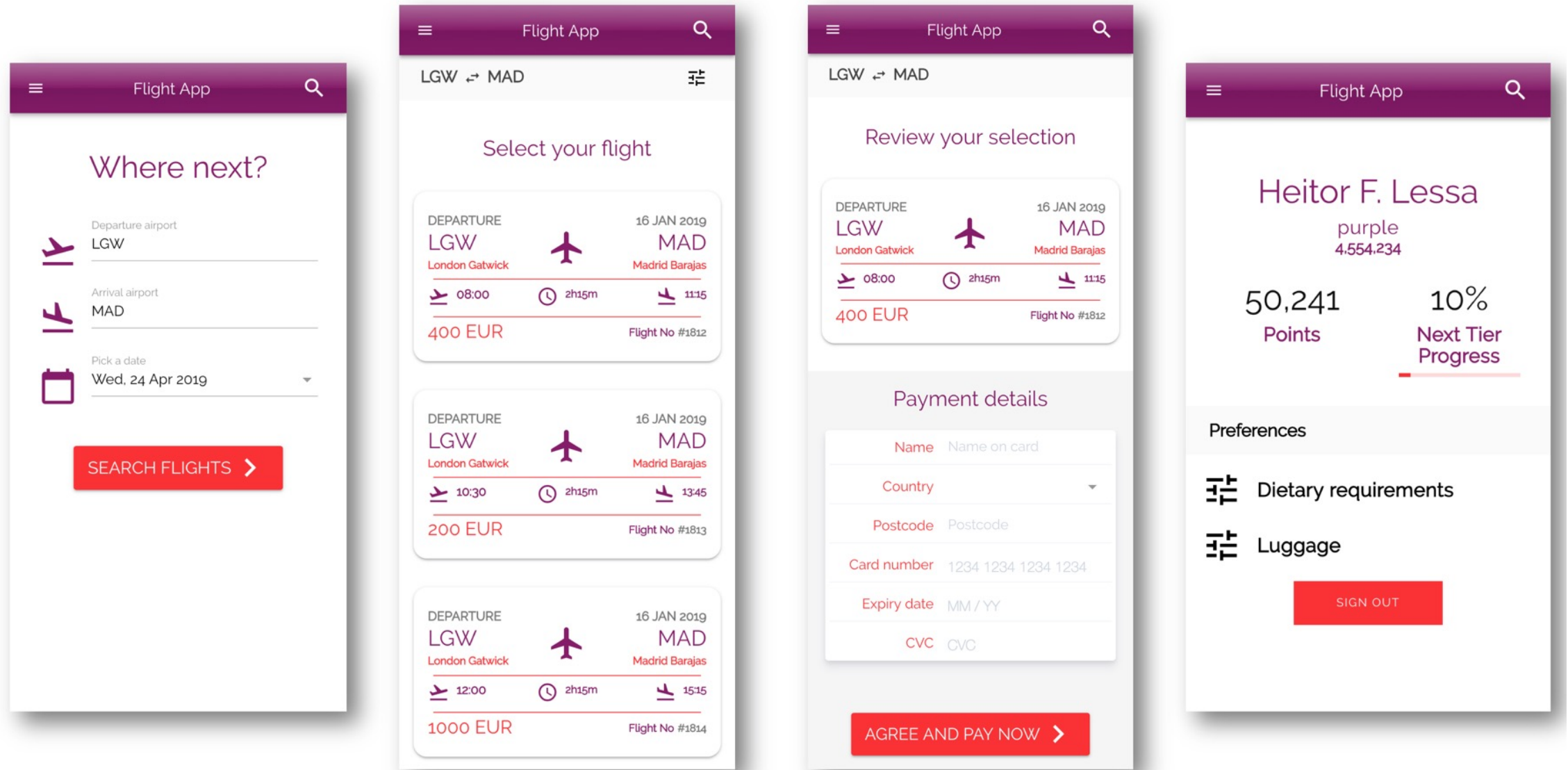



AWS Serverless Airline Booking Stack

UI/UX



Quasar framework



Vue.js



AWS Amplify



Stripe Elements

Data/Lang

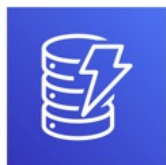

Amazon DynamoDB



Python



Typescript



JavaScript

API/Auth

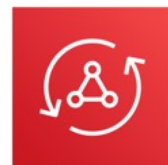

AWS AppSync



Amazon API Gateway

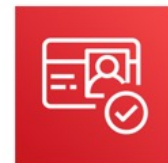

Amazon Cognito

Messaging



Amazon SNS



AWS Step Functions



AWS Serverless Airline Booking

High level infrastructure architecture

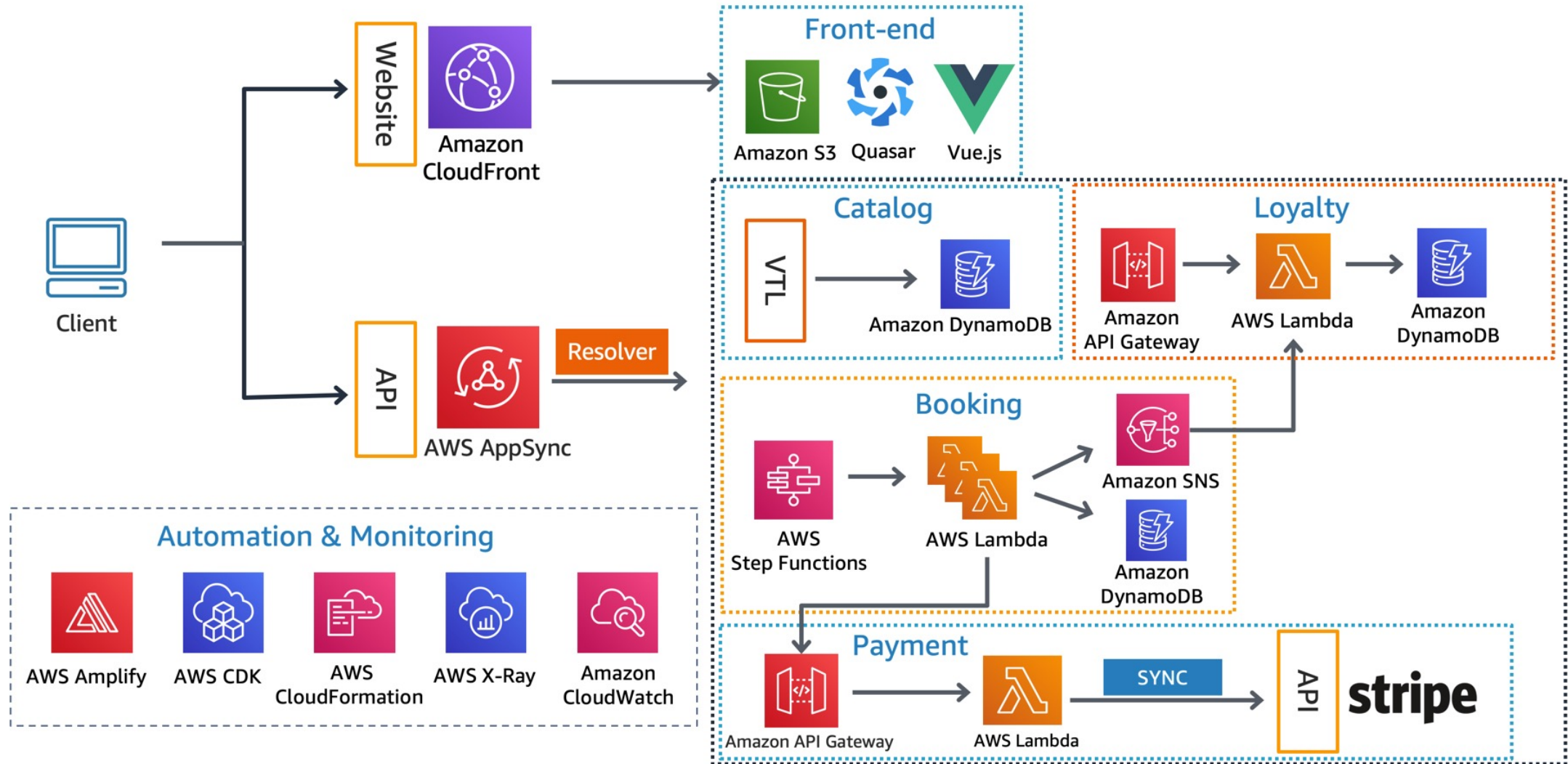

© 2019, Amazon Web Services, Inc. or its affiliates. All rights reserved.



AWS Serverless Architecture

AWS Operational Responsibility Models

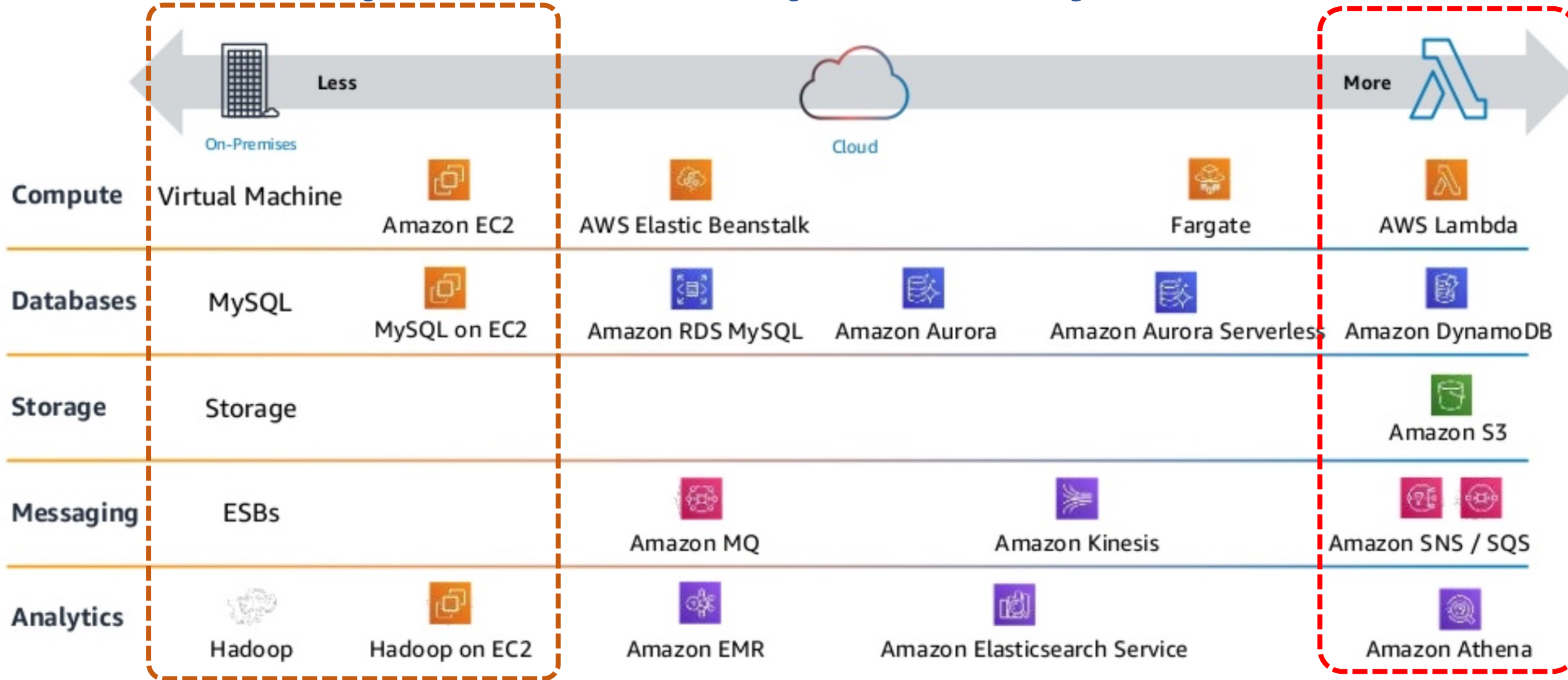



Build a Serverless Web Application

aws Build a Serverless Web Application

Projects on AWS:

Build a Serverless Web Application

with AWS Lambda, Amazon API Gateway, Amazon S3, Amazon DynamoDB, and Amazon Cognito

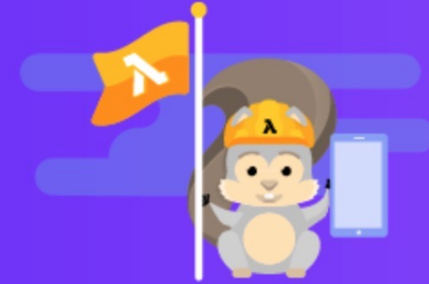

Introduction

1

Host a static website

2

Manage users

3

Build a serverless backend

4

Deploy a RESTful API

5

Terminate resources

Overview

In this tutorial, you'll create a simple serverless web application that enables users to request unicorn rides from the [Wild Rydes](#) fleet. The application will present users with an HTML based user interface for indicating the location where they would like to be picked up and will interface on the backend with a RESTful web service to submit the request and dispatch a nearby unicorn. The application will also provide facilities for users to register with the service and log in before requesting rides.

Application Architecture

AWS Experience: Beginner

Time to complete: 2 hours

Cost to complete: Each service used in this architecture is eligible for the [AWS Free Tier](#). If you are outside the usage limits of the Free Tier, completing this tutorial will cost you less than \$0.25*.



Build a Serverless Web Application

with Amazon S3, AWS Lambda, Amazon API Gateway, Amazon DynamoDB, and Amazon Cognito

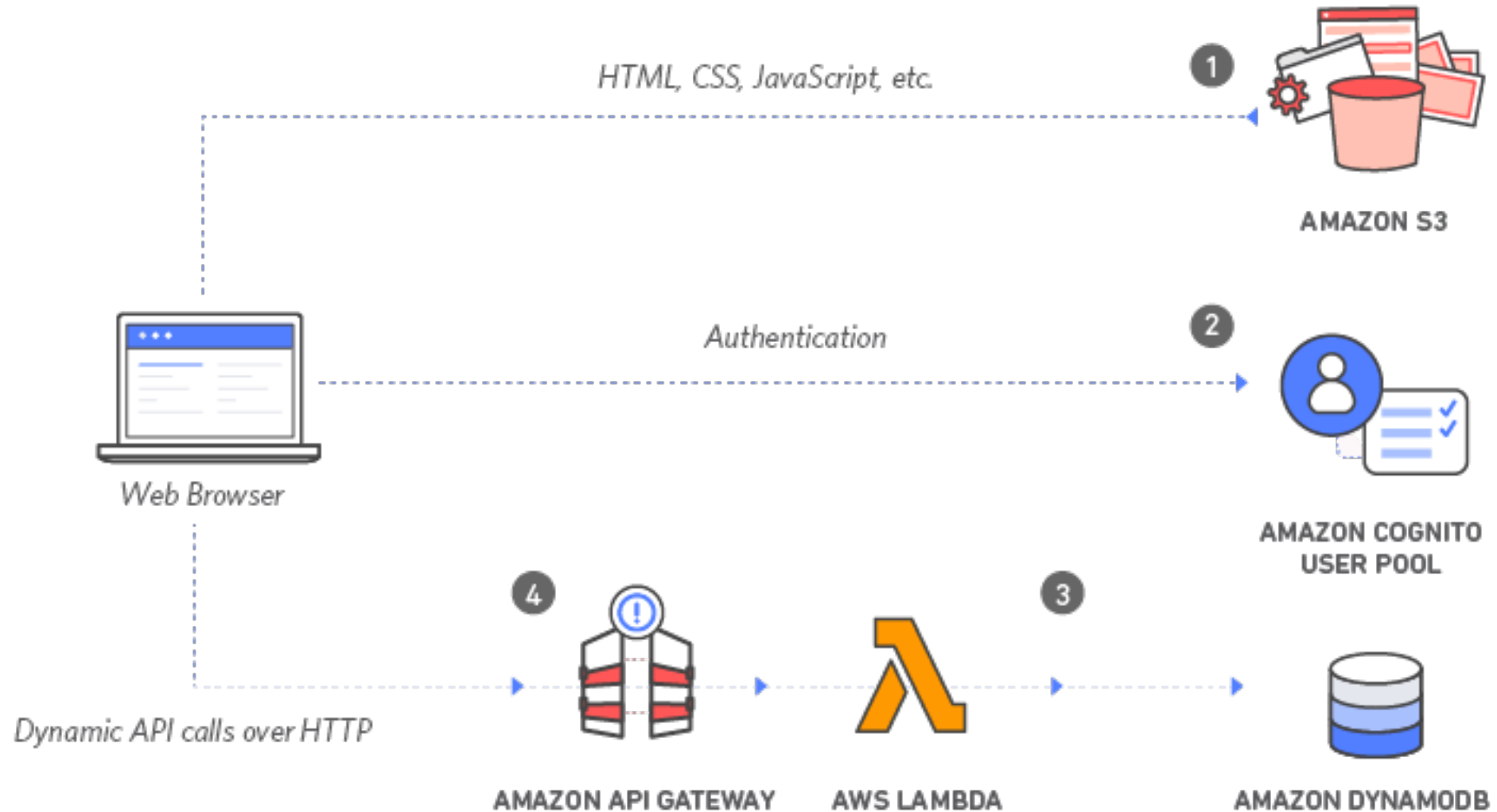



Build a Serverless Web Application

with Amazon S3, AWS Lambda, Amazon API Gateway, Amazon DynamoDB, and Amazon Cognito

1





Build a Serverless Web Application

with Amazon S3, AWS Lambda, Amazon API Gateway, Amazon DynamoDB, and Amazon Cognito

1

Static Web Hosting

Amazon S3 hosts static web resources including HTML, CSS, JavaScript, and image files which are loaded in the user's browser.

HTML, CSS, JavaScript, etc.





Build a Serverless Web Application

with Amazon S3, AWS Lambda, Amazon API Gateway, Amazon DynamoDB, and Amazon Cognito

2

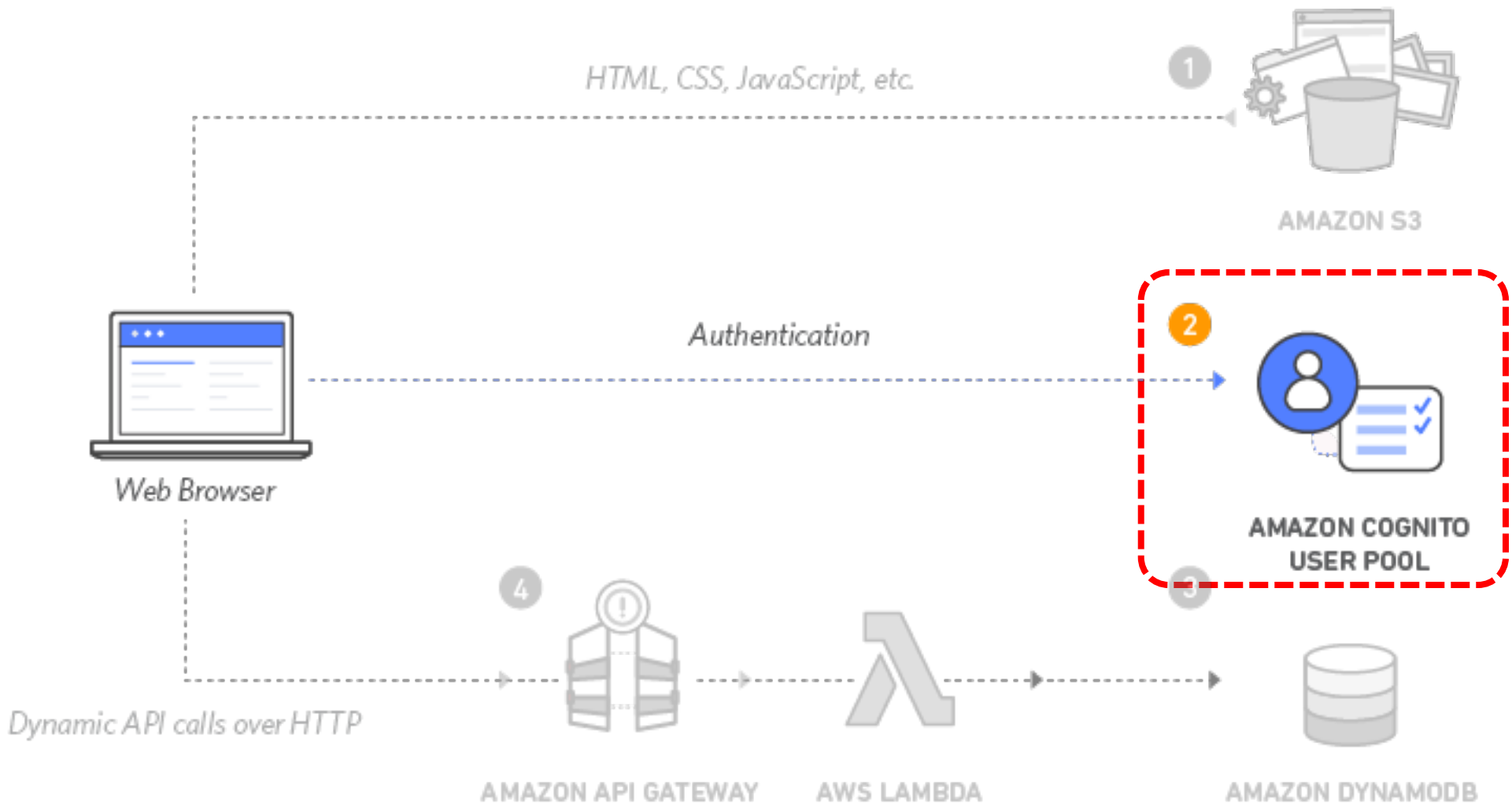



Build a Serverless Web Application

with Amazon S3, AWS Lambda, Amazon API Gateway, Amazon DynamoDB, and Amazon Cognito

2

User Management

Amazon Cognito provides user management and authentication functions to secure the backend API.

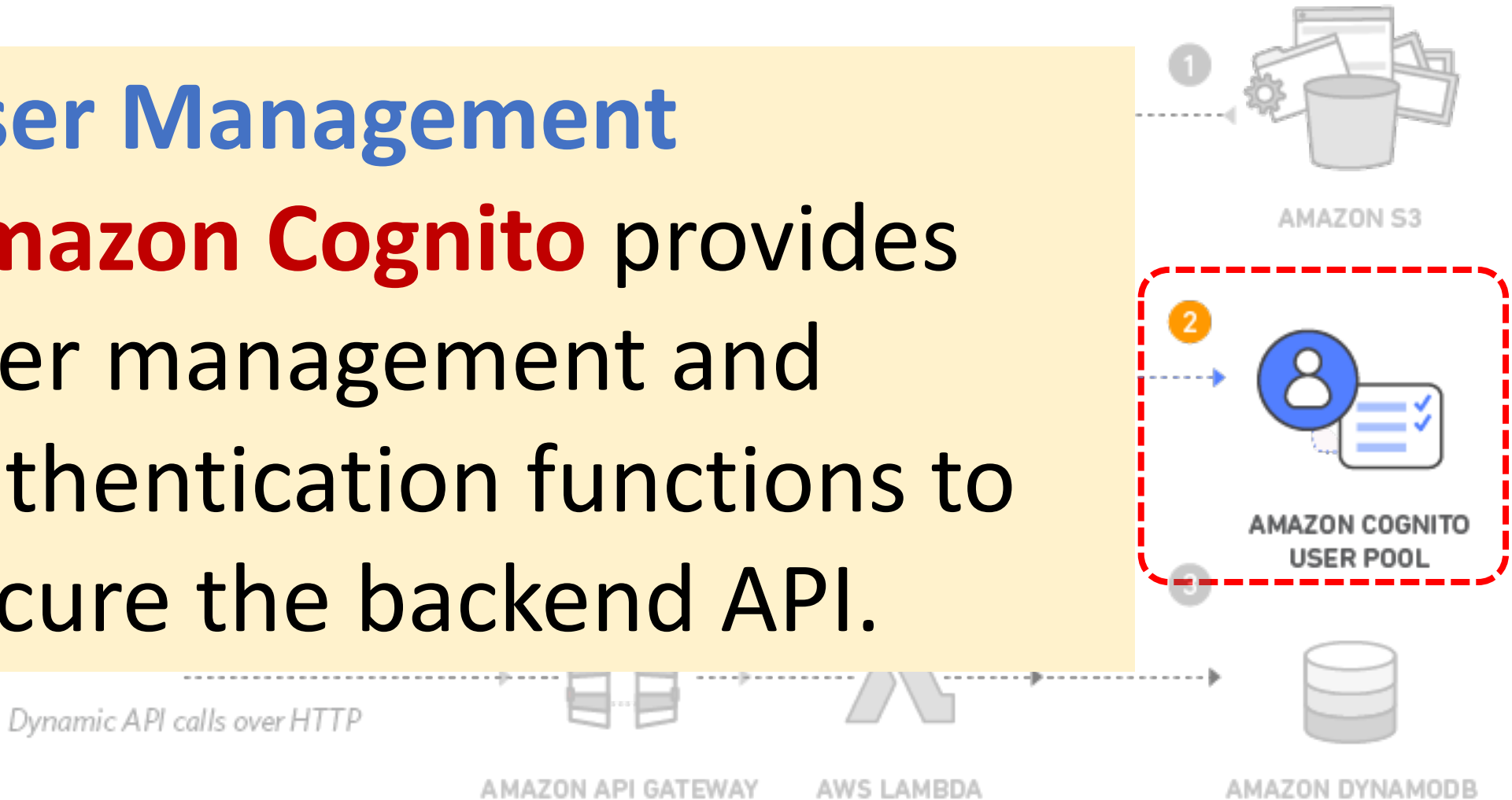



Build a Serverless Web Application

with Amazon S3, AWS Lambda, Amazon API Gateway, Amazon DynamoDB, and Amazon Cognito

3

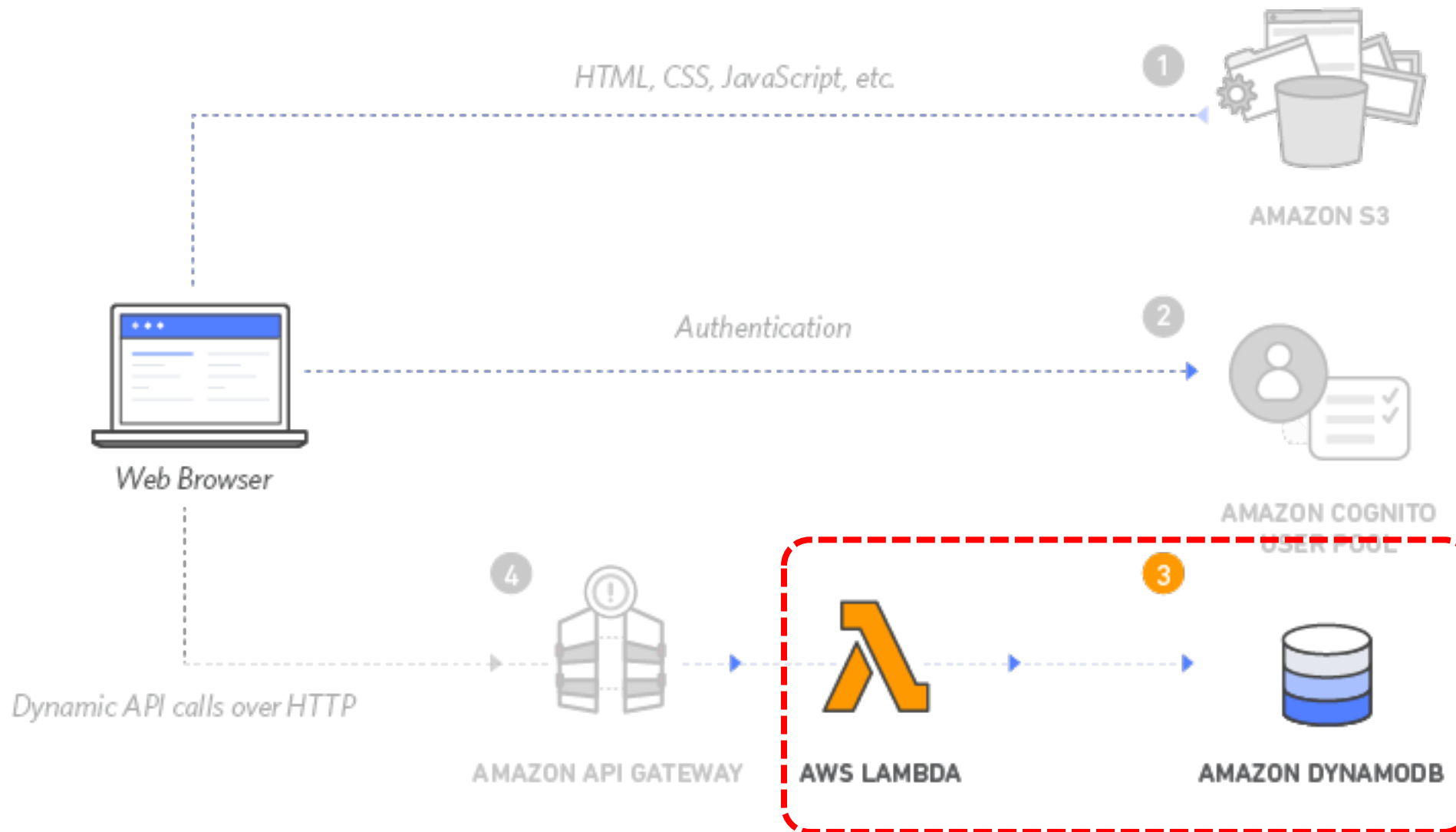



Build a Serverless Web Application

with Amazon S3, AWS Lambda, Amazon API Gateway, Amazon DynamoDB, and Amazon Cognito

3

Serverless Backend

Amazon DynamoDB provides a persistence layer where data can be stored by the API's **Lambda** function.

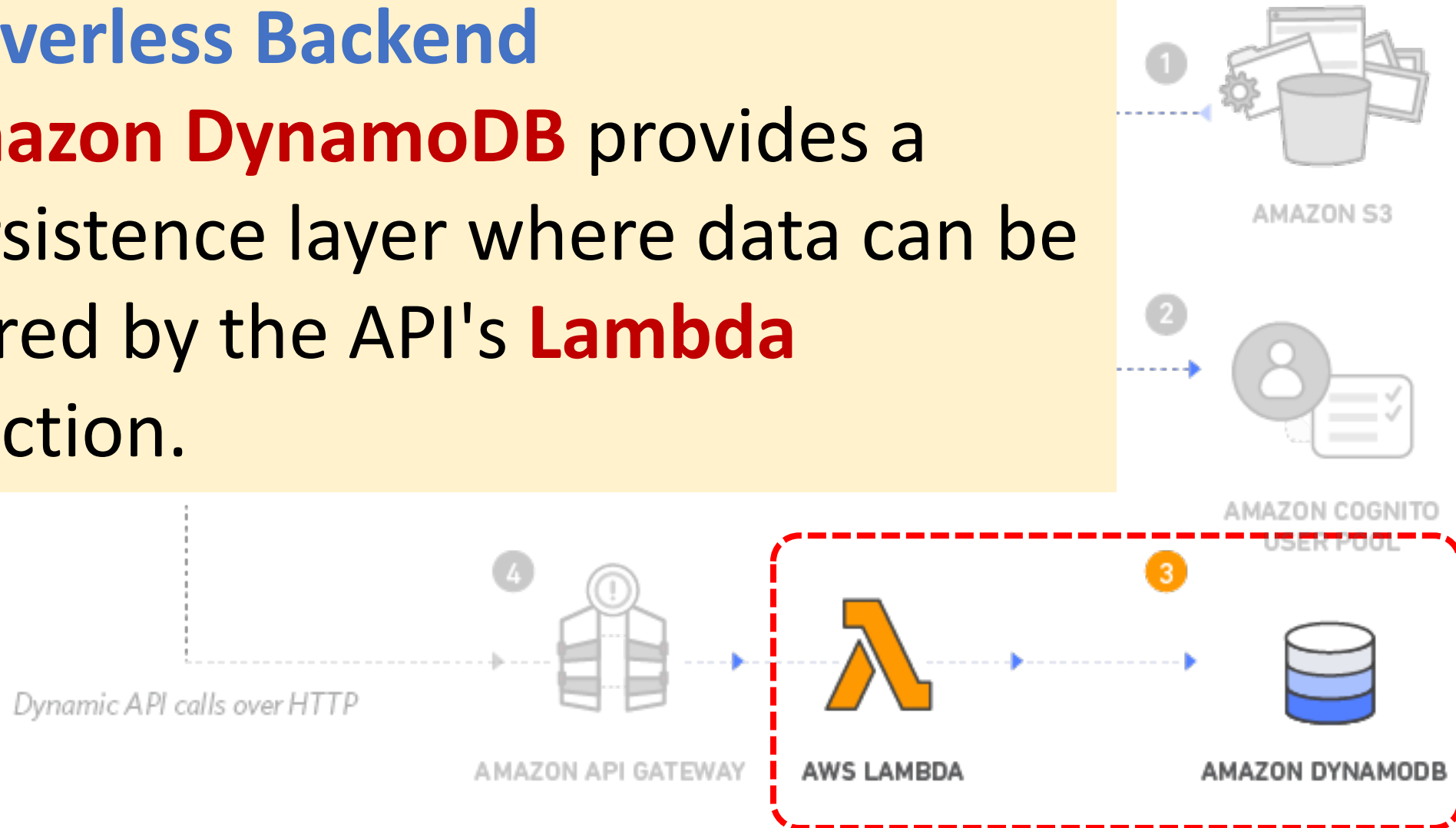



Build a Serverless Web Application

with Amazon S3, AWS Lambda, Amazon API Gateway, Amazon DynamoDB, and Amazon Cognito

4

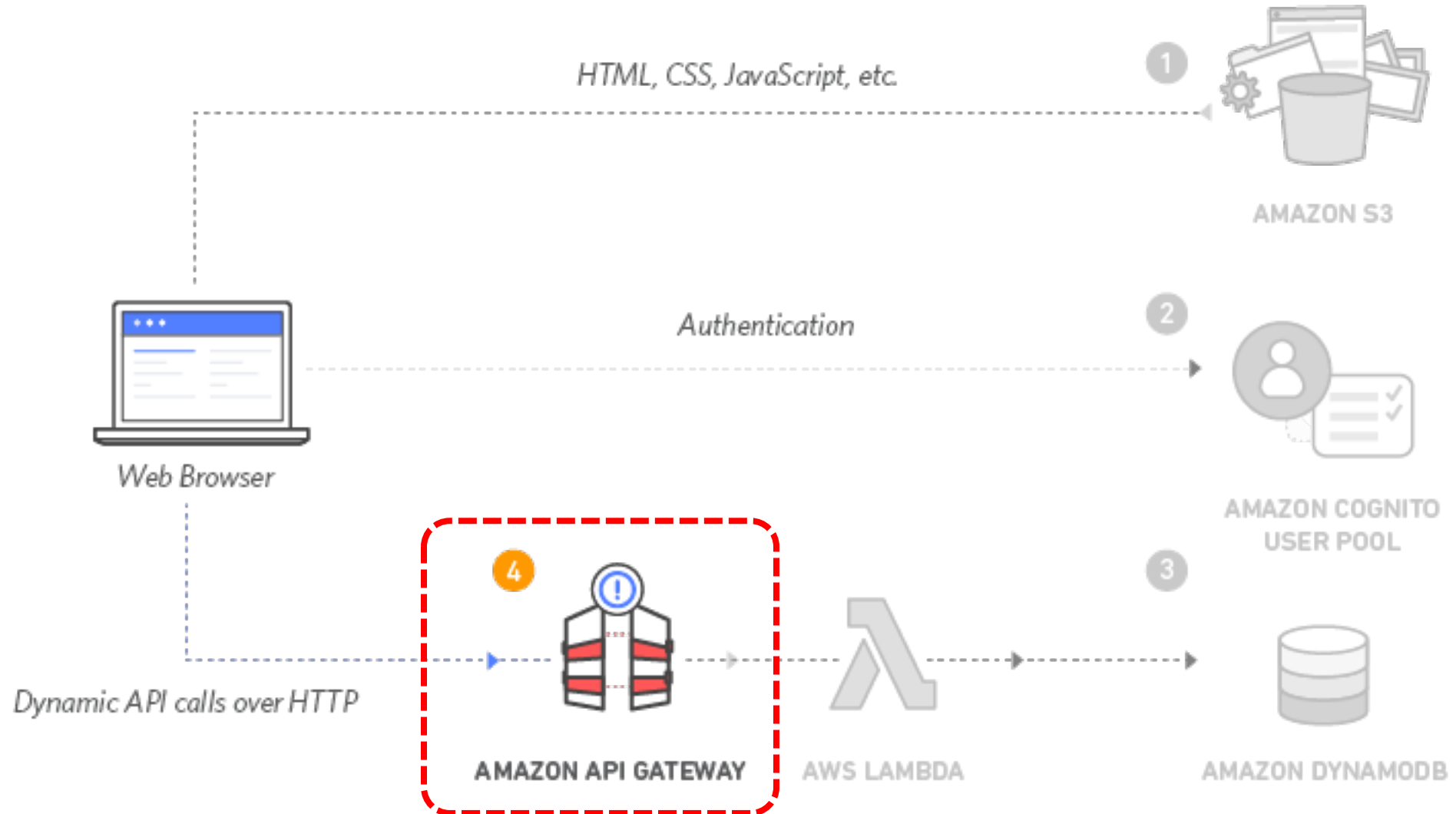



Build a Serverless Web Application

with Amazon S3, AWS Lambda, Amazon API Gateway, Amazon DynamoDB, and Amazon Cognito

4

RESTful API

JavaScript executed in the browser sends and receives data from a public backend API built using **Lambda** and **API Gateway**.

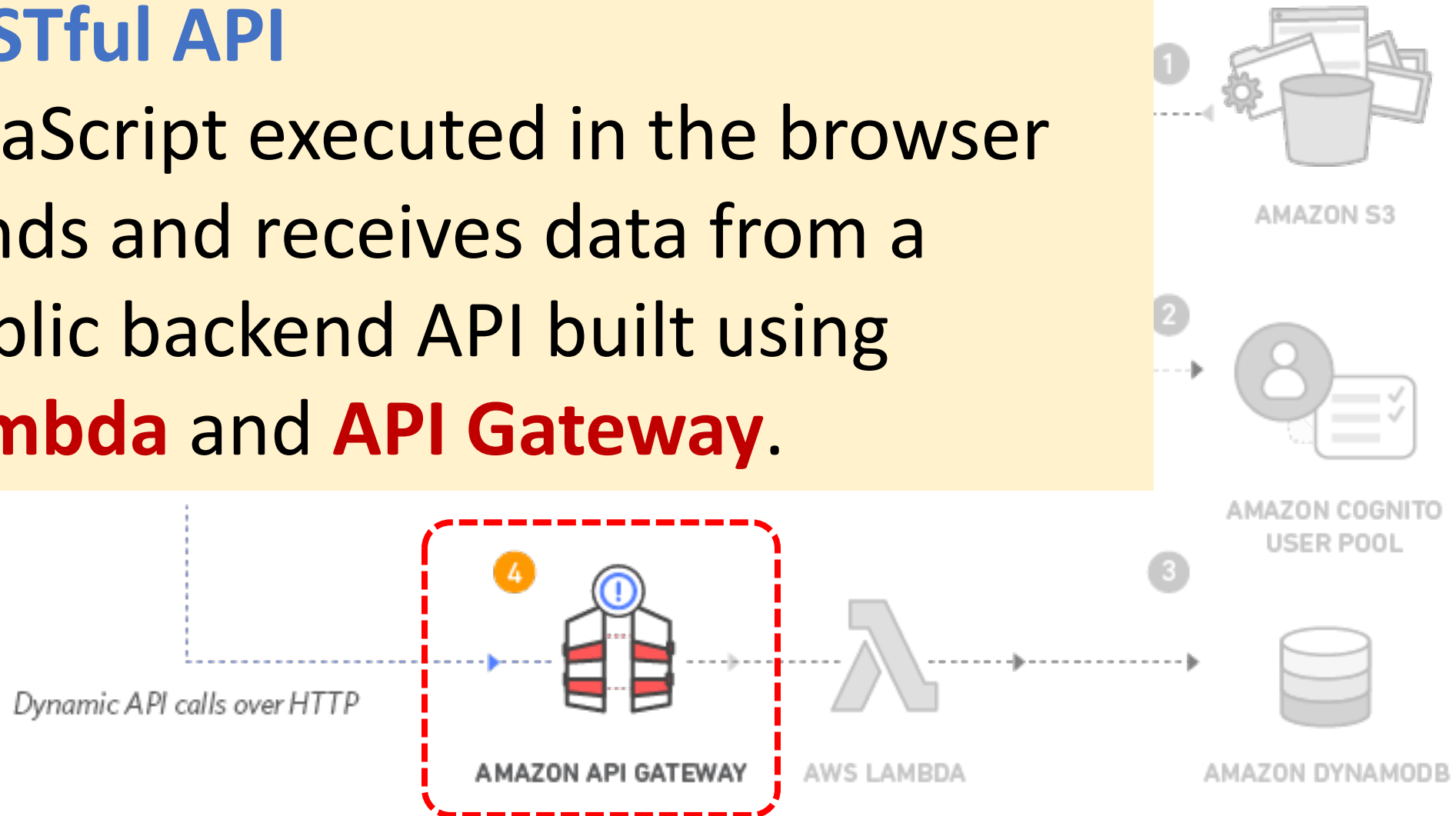



Build a Serverless Web Application

with Amazon S3, AWS Lambda, Amazon API Gateway,
Amazon DynamoDB, and Amazon Cognito

5 Terminate resources

Resource Cleanup

You will terminate an **Amazon S3** bucket, an **Amazon Cognito** User Pool, an **AWS Lambda** function, an **IAM** role, a **DynamoDB** table, a **REST API**, and a **CloudWatch** Log.

It is a best practice to **delete resources** you are no longer using to avoid unwanted charges.

References

- <https://aws.amazon.com/certification/>
- <https://www.aws.training/>
- <https://aws.amazon.com/training/awsacademy/>
- <https://aws.amazon.com/education/awseducate/>
- **AWS Certified Cloud Practitioner**
 - <https://aws.amazon.com/certification/certified-cloud-practitioner/>
- **AWS Certified Solutions Architect – Associate**
 - <https://aws.amazon.com/certification/certified-solutions-architect-associate/>
- **AWS Cloud Practitioner Essentials (Second Edition)**
 - <https://aws.amazon.com/training/course-descriptions/cloud-practitioner-essentials/>
- **Architecting on AWS**
 - <https://aws.amazon.com/training/course-descriptions/architect/>



Q & A

Introduction to Amazon Web Services (AWS) Certifications Roadmap

Host: 陳仁偉 教授 (Prof. Jen Wel Chen)
Information Management, SEC, Chinese Culture University
Time: 2022/3/13 (Sunday) 13:00-15:00
Place: 202教室 大夏館 台北市建國南路二段231號

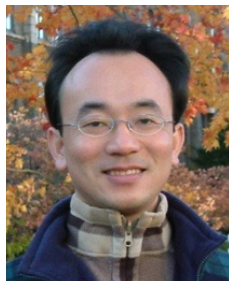

戴敏育 副教授

Min-Yuh Day, Ph.D, Associate Professor

國立臺北大學 資訊管理研究所

Institute of Information Management, National Taipei University

<https://web.ntpu.edu.tw/~myday>

2022-03-13

